

IF A SEAL IS PRESENT ON THIS SHEET IT HAS BEEN ELECTRONICALLY SEALED AND DATED.

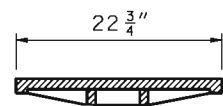

SECTION A-A

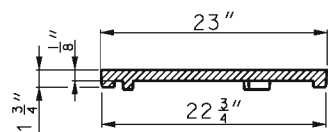

SECTION C-C

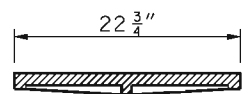

SECTION E-E

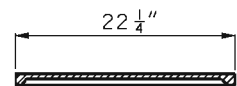

SECTION G-G

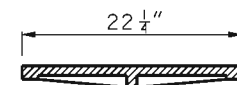

SECTION I-I

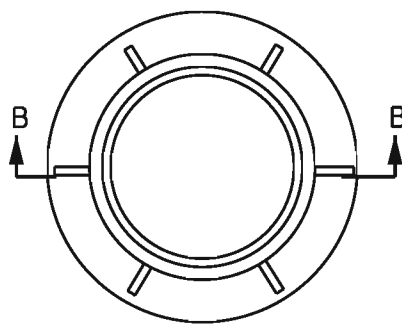
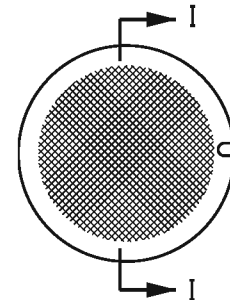
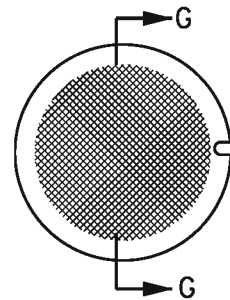
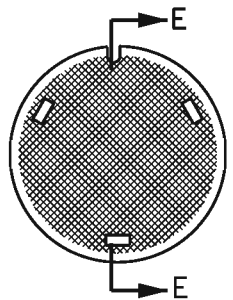
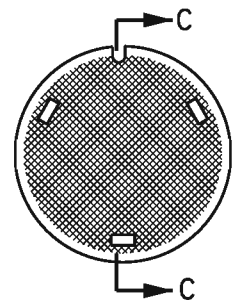
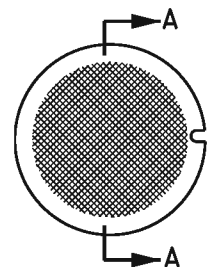

PLAN

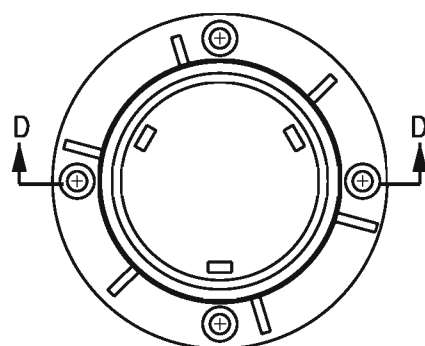

PLAN

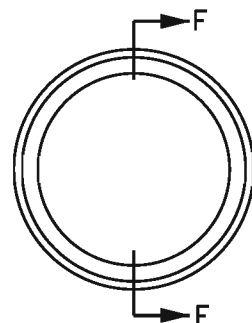

PLAN

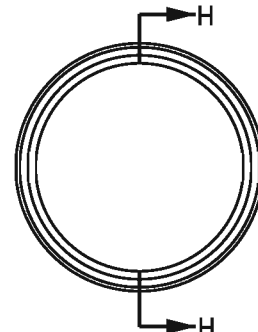

PLAN

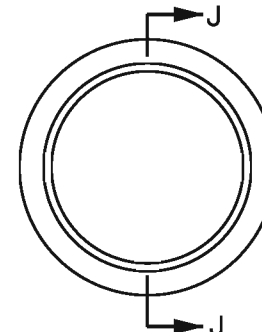

PLAN

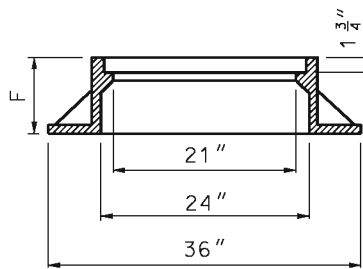

SECTION B-B

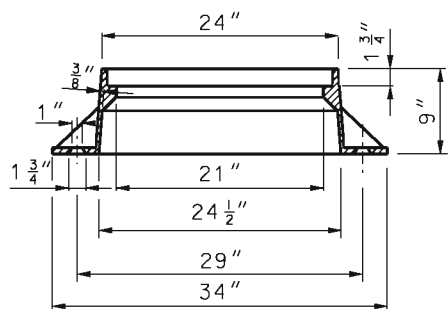

SECTION D-D

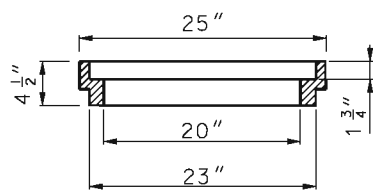

SECTION F-F

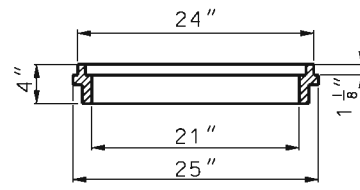

SECTION H-H

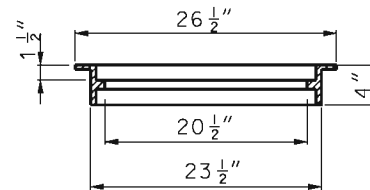

SECTION J-J

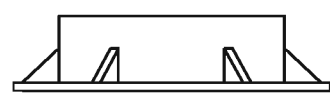

ELEVATION  
TYPE 1A AND 1B

APPROXIMATE WEIGHT OF  
FRAME AND COVER  
TYPE 1A 540 LBS.  
TYPE 1B 570 LBS.

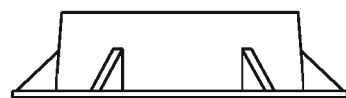

ELEVATION  
TYPE 1C

APPROXIMATE WEIGHT OF  
FRAME AND COVER 290 LBS.

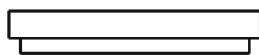

ELEVATION  
TYPE 2

APPROXIMATE WEIGHT OF  
FRAME AND COVER 250 LBS.

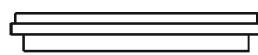

ELEVATION  
TYPE 3

APPROXIMATE WEIGHT OF  
FRAME AND COVER 115 LBS.



ELEVATION  
TYPE 4

APPROXIMATE WEIGHT OF  
FRAME AND COVER 160 LBS.

GENERAL NOTES:

TYPE 1A:  
WHEN "P" (PAVEMENT THICKNESS) IS 8" USE MANHOLE  
FRAME WITH 9" HEIGHT (F) APPROXIMATE WEIGHT OF  
FRAME AND COVER, 540 LBS., CLASS 35 CASTING.

TYPE 1B:  
WHEN "P" (PAVEMENT THICKNESS) IS 9" OR 10", USE  
MANHOLE FRAME WITH 10" HEIGHT (F) APPROXIMATE  
WEIGHT OF FRAME AND COVER, 570 LBS., CLASS 35  
CASTING.

TYPE 1C:  
TYPE 1C MANHOLE FRAME AND COVER WILL BE ACCEPTED AS  
AN ALTERNATE TO TYPE 1A OR TYPE 1B. APPROXIMATE  
WEIGHT OF FRAME AND COVER, 290 LBS..

FOR "P" GREATER THAN 10" ADJUSTING RINGS COMBINED  
WITH MANHOLE FRAMES WITH "F" EQUAL TO 9" OR 10"  
SHALL BE USED TO MATCH THE PAVEMENT THICKNESS.

THE PRICE BID FOR MANHOLE FRAME AND COVER SHALL  
INCLUDE THE NUMBER OF ADJUSTING RINGS REQUIRED TO  
MATCH PAVEMENT THICKNESS.

WHEN SPECIFIED, USE A LOCK TYPE FRAME AND COVER  
WITH A MINIMUM OF 3 LOCK BLOCKS AND BOLTS.

MANHOLE ADJUSTING RINGS SHALL BE SECURED TO EITHER  
THE FRAME OR PAVEMENT TO PREVENT MOVEMENT UNDER  
TRAFFIC.

A CHECKERED DESIGN TOP SHALL BE FURNISHED.

**MoDOT** MISSOURI HIGHWAYS AND TRANSPORTATION  
COMMISSION  
105 WEST CAPITOL  
JEFFERSON CITY, MO 65102  
1-888-ASK-MODOT (1-888-275-6636)

STATE OF MISSOURI  
KATHRYN  
PHILLIPS HARVEY  
NUMBER  
PE-23751  
PROFESSIONAL ENGINEER  
THIS SHEET HAS BEEN  
SIGNED, SEALED, AND DATED  
ELECTRONICALLY.

**MANHOLE  
FRAMES AND COVERS**

DATE EFFECTIVE: 03/01/1996	<b>614.30E</b>	SHEET NO.
DATE PREPARED: 8/21/2009		1 OF 2

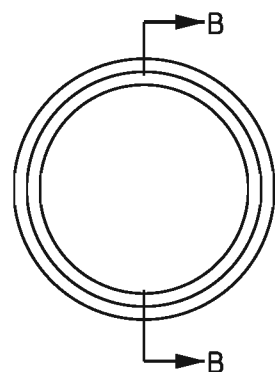

PLAN

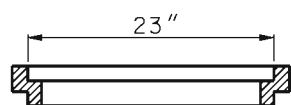

SECTION B-B

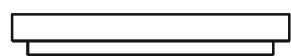

ELEVATION

ADJUSTING RING  
SOLID OR ADJUSTABLE

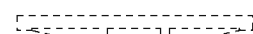

COVER

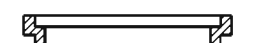

ADJUSTING RING

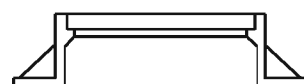

FRAME

INSTALLATION  
DETAILS

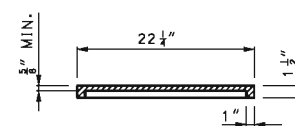

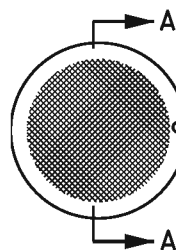

SECTION A-A



APPROXIMATE WEIGHT OF  
FRAME AND COVER 150 LBS.

ALTERNATE  
TYPE 4 COVER

	<b>MISSOURI HIGHWAYS AND TRANSPORTATION COMMISSION</b> 105 WEST CAPITOL JEFFERSON CITY, MO 65102 1-888-ASK-MODOT (1-888-275-6636)	
		<h2>MANHOLE FRAMES AND COVERS</h2>
DATE EFFECTIVE: 03/01/1996 DATE PREPARED: 8/21/2009	<h1>614.30E</h1>	SHEET NO. <b>2 OF 2</b>

IF A SEAL IS PRESENT ON THIS SHEET IT HAS BEEN ELECTRONICALLY SEALED AND DATED.