

# GARTH AVENUE AND ROUTE 763 (RANGELINE) TYPICAL CONSTRUCTION PHASING

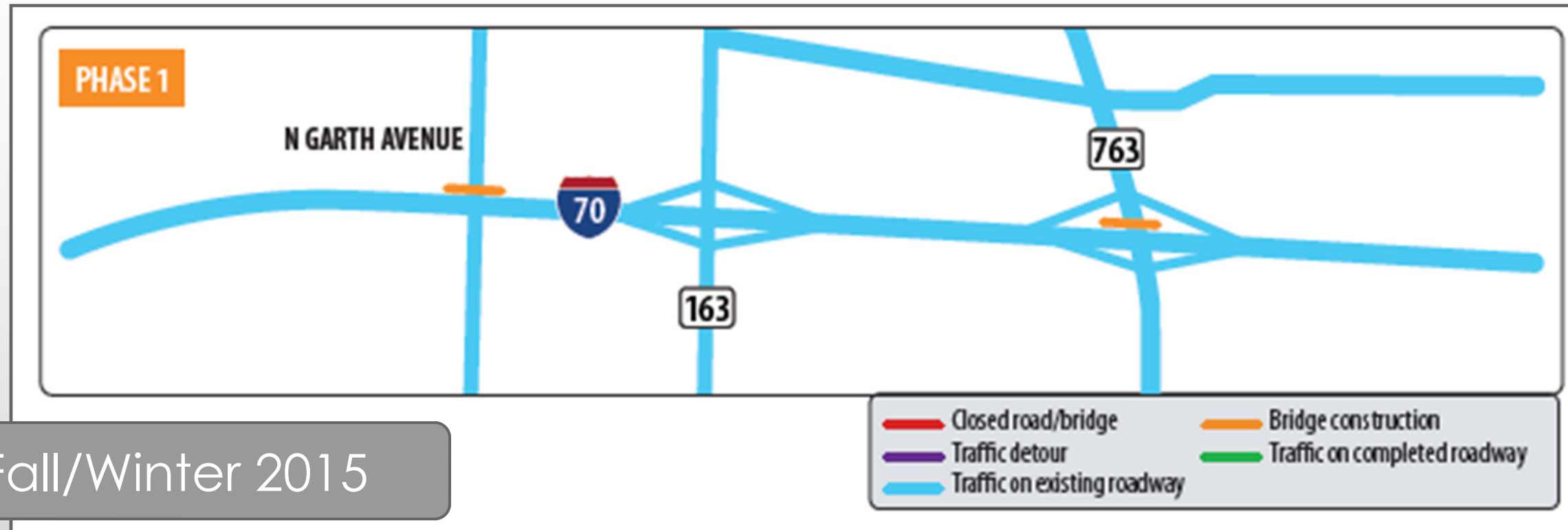

Fall/Winter 2015

*I-70 over Garth Avenue Phasing Typical Section*

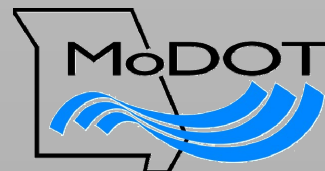
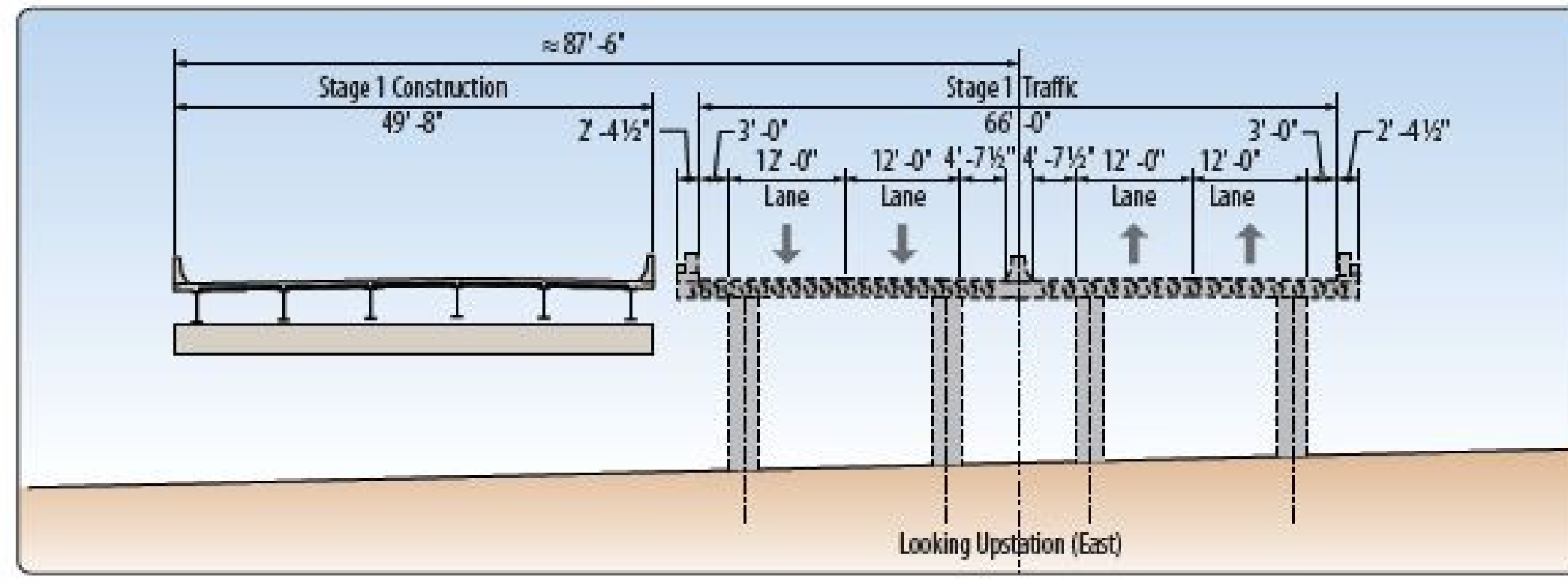

# GARTH AVENUE AND ROUTE 763 (RANGELINE) TYPICAL CONSTRUCTION PHASING

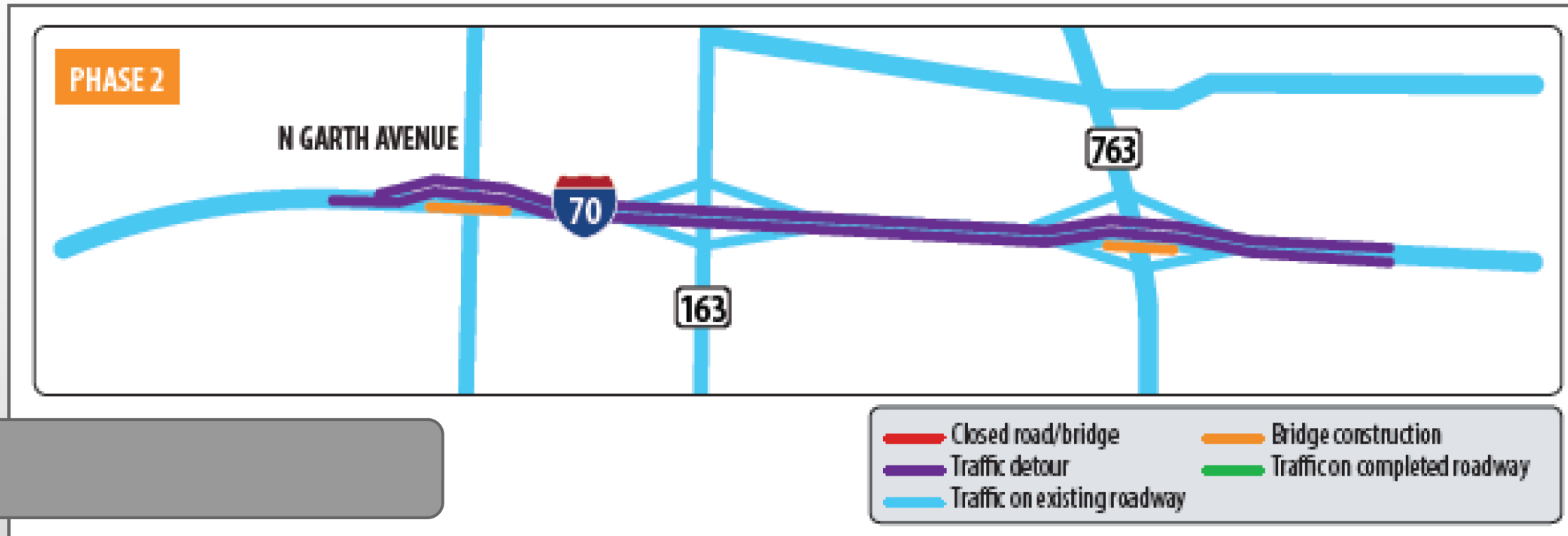

*I-70 over Garth Avenue Phasing Typical Section*

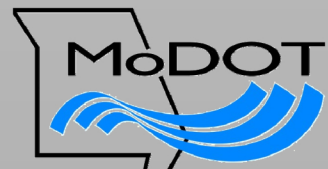
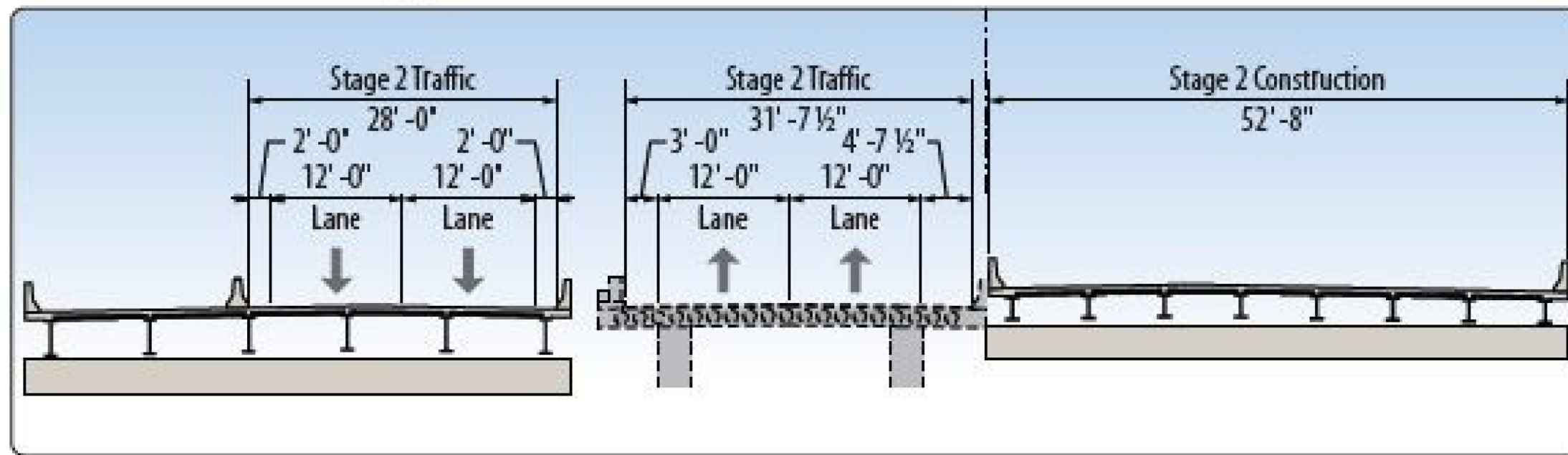

# GARTH AVENUE AND ROUTE 763 (RANGELINE) TYPICAL CONSTRUCTION PHASING

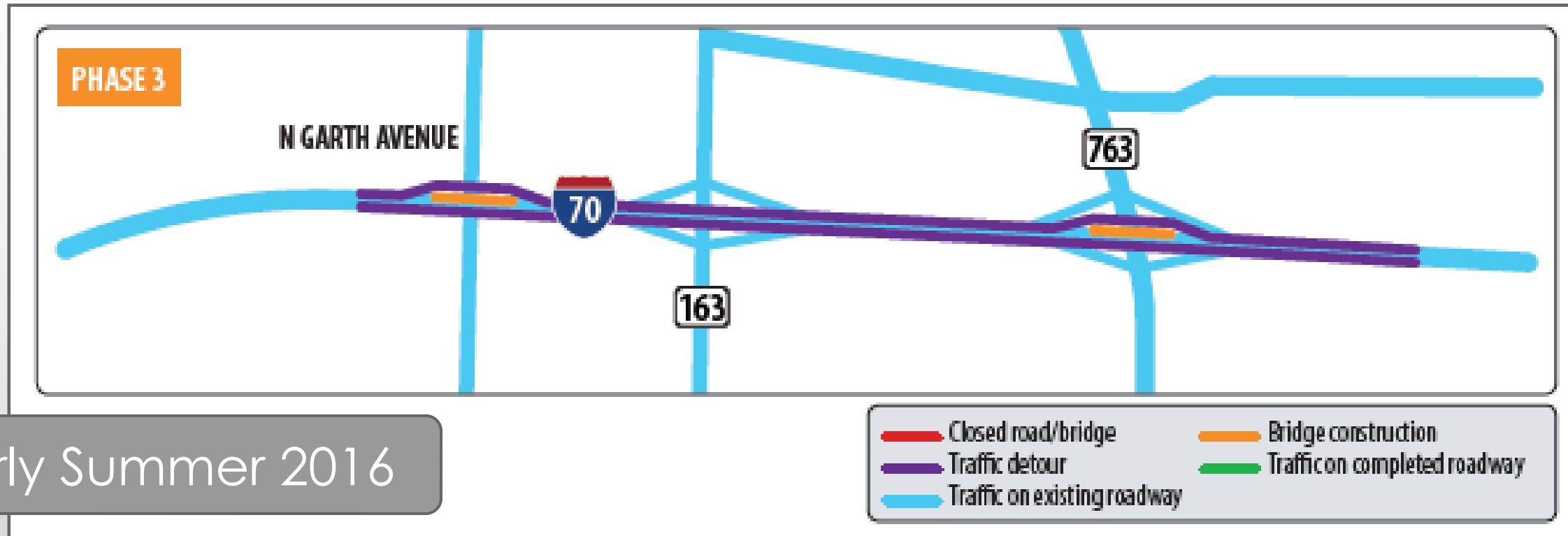

Early Summer 2016

*I-70 over Garth Avenue Phasing Typical Section*

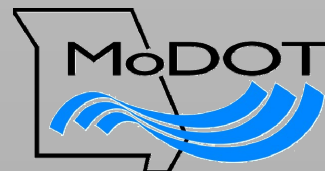
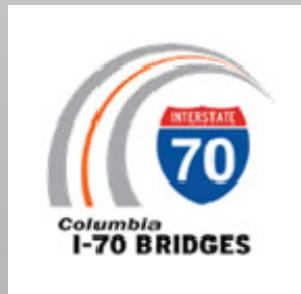
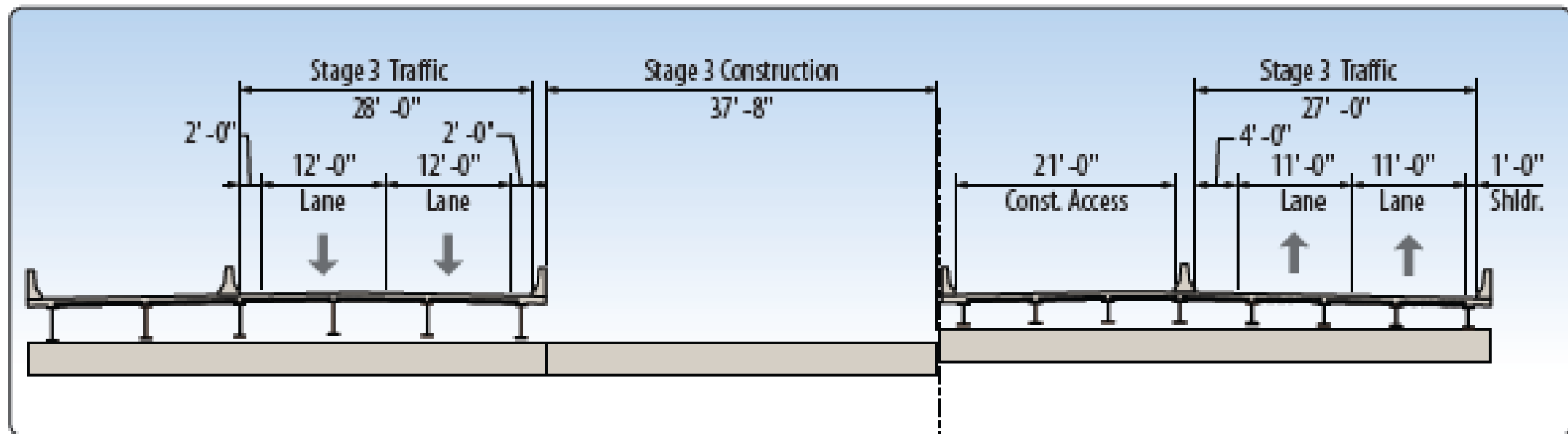

EMERY SAPP & SONS, INC.

**PARSONS**

# GARTH AVENUE AND ROUTE 763 (RANGELINE) TYPICAL CONSTRUCTION PHASING

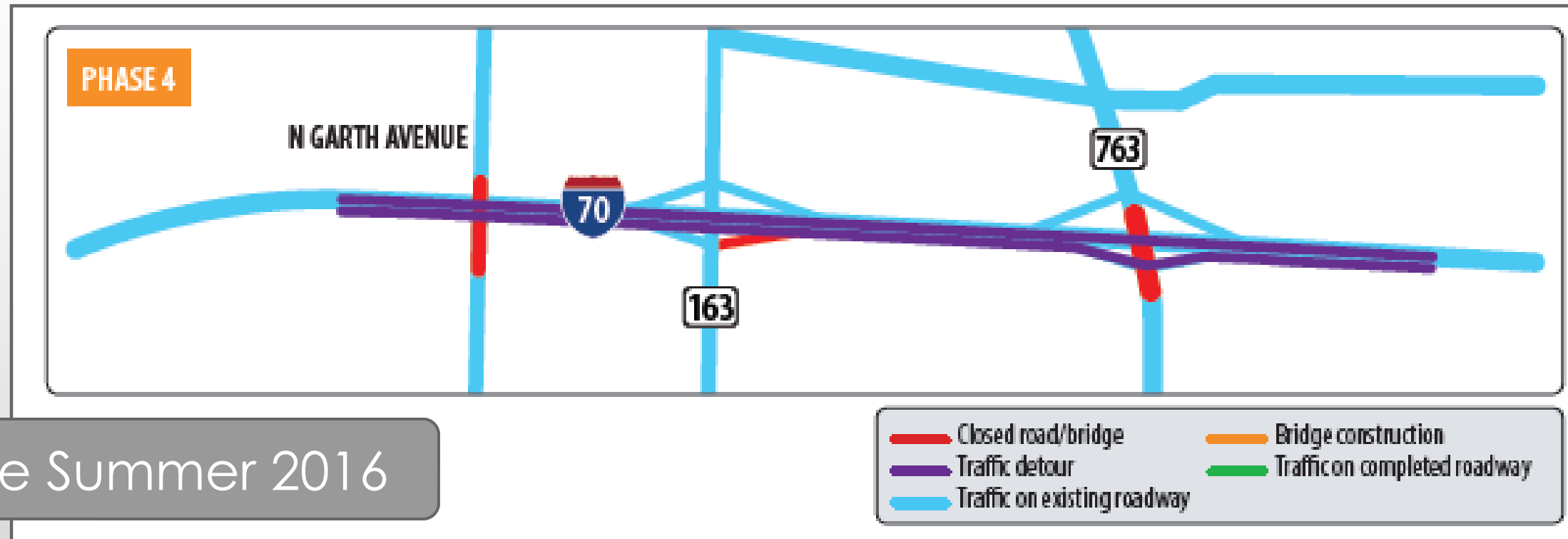

Late Summer 2016

## I-70 over Garth Avenue Phasing Typical Section

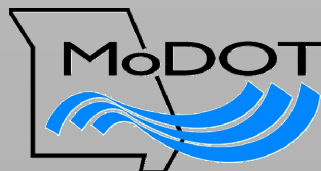
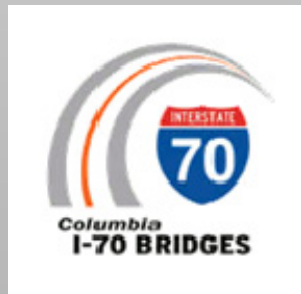
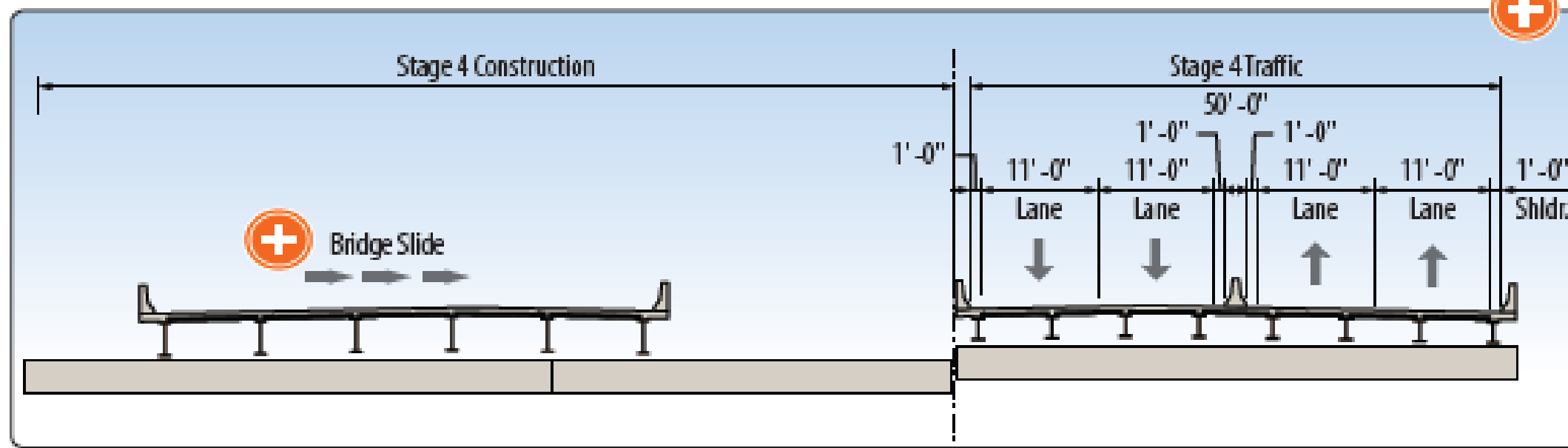

**PARSONS**